

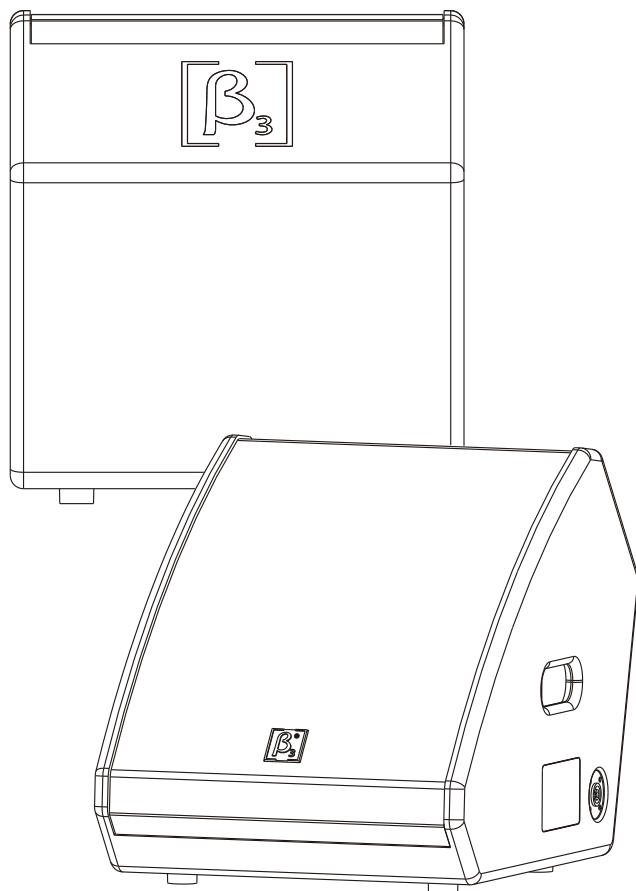

Beta Three



MU12M

12" TwoWay Full Range Monitor

USER MANUAL





UM-MU12M-20090828 ver A



SAFETY INSTRUCTIONS

PLEASE READ THIS MANUAL FIRST

Thank you for a buying β_3 product. Read this manual first as it will help you operate the system properly. Please keep this manual for future reference.

⚠ WARNING: *This product must be installed by professionals. When using hanging brackets or rigging other than those supplied with the product, please ensure they comply with the local safety codes.*

| | | |
|---|---|---|
|  | CAUTION RISK OF ELECTRICAL SHOCK DO NOT OPEN |  |
| CAUTION: TO REDUCE THE RISK OF ELECTRIC SHOCK, DO NOT REMOVE COVER (OR BACK). NO USER-SERVICABLE PARTS INSIDE. REFER SERVICING TO QUALIFIED PERSONNEL. | | |

| | | |
|--|---|---|
|  | AVIS RISQUE DE CHOC ÉLECTRIQUE NE PAS OUVRIR |  |
| ATTENTION : POUR RÉDUIRE LE RISQUE DE DÉCHARGE ÉLECTRIQUE, NE RETIREZ PAS LE COUVERCLE (OU L'ARRIÈRE). IL NE SE TROUVE À L'INTÉRIEUR AUCUNE PIÈCE POUVANT ÊTRE RÉPARÉE PAR L'USAGER. S'ADRESSER À UN RÉPARATEUR COMPÉTENT. | | |

 *The exclamation point within an equilateral triangle is intended to alert you to the presence of important operating and servicing instructions.*

⚠ ATTENTION: *Don't refit the system or spare parts without being authorized as this will void the warranty.*

⚠ WARNING: *Don't place naked flames (such as candles) close to the equipment.*

1. Read the instruction manual first before using this product.
2. Please keep this manual for future reference
3. Pay attention to all warnings.
4. Obey all operating instructions.
5. Do not expose this product to rain or moisture.
6. Clean this equipment with a dry cloth.
7. Do not block any ventilation openings. Install according to manufacturer's instructions .
8. Do not install this product near any heat source, such as a, heater, burner, or any other equipment with heat radiation .
9. Only use spare parts supplied by the manufacturer.
10. Pay attention to the safety symbol on the outside of the cover.



CONTENT

| | |
|--|---|
| INTRODUCTION | 3 |
| Features | 3 |
| Description | 3 |
| Applications | 3 |
| CONNECTION | 4 |
| Wiring Connection | 4 |
| System Connection Reference | 4 |
| Loudspeaker Connection | 5 |
| SPECIFICATION | 6 |
| Technical Sheet | 6 |
| Frequency Response And Impedance Curve | 7 |
| 2D Dimension | 7 |

 Product information subjects to be updated without notification, please visit www.elderaudio.com for latest update.

MU12M

12" two way full range monitor

Features

- 12" Neodymium woofer with 3" voice coil.
- Neodymium compression driver with 3" voice coil.
- Dispersion 45° × 45°.
- Monitor angle 50°.
- Sensitivity is 97dB, Max. SPL is 121dB.
- RMS power is 350W, peak power is 1400W.
- Ergonomic cabinet design.

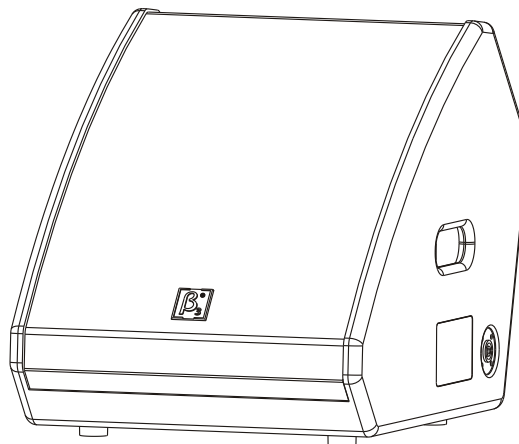

Description

β₃[®] MU12M is a professional and compact monitor system, it is suitable for all the demanding monitor applications.

Adopted Neodymium compression driver integrate 3" polymer diaphragm to assure the big power output and delivery natural sound performance, the dispersion is 45°x45°. 12" Neodymium woofer integrate 3" voice coil and latest improved magnet circuit & short-circuit ring to achieve the low distortion and Max. clarity under high SPL.

Very compact design, light weight and very powerful.

Perfect protection circuit design makes sure the system working smoothly and safely.

MU12M produce 121dB SPL continuously and 80-16kHz frequency response, suitable for different applications from small to large scale, including the speech and full range applications.

MU12M adopts the ergonomic cabinet design. Large arc cabinet effectively reduce the collision harm, round handle design make the carrying very balanced during the transport.

NL4 connectors are available at the both sides to optimize the system wiring. Cabinet is made of 15mm Russian birch plywood with advanced environmental protection. polyurethane-based painting. Steel grille is coated by powder to provide strong ultra-Weatherability.

Applications

- | | |
|------------------------|----------------------|
| ■ Auditorium | ■ Dance Club |
| ■ Theater | ■ Hall Performance |
| ■ Multifunctional hall | ■ Living Performance |



MU12M
12" two way fullrange monitor

CONNECTION

Two NL4 connectors are available for amplifier connections. Paralleled connector is very convenient for another speaker connection.

Speakon

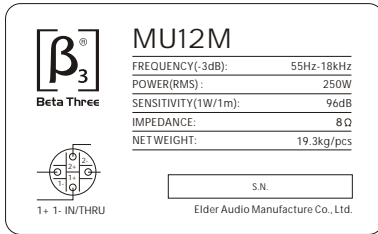

1+ 1- INPUT

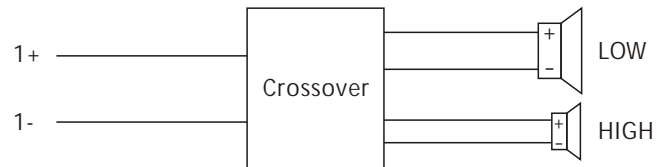

NL4 Wiring Connection

1. Connect

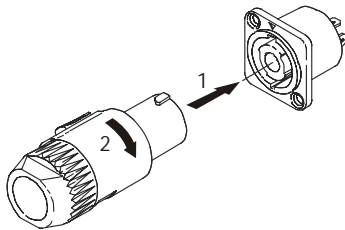

2. Disconnect

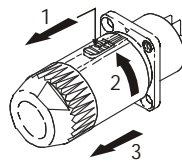

System Connection Reference

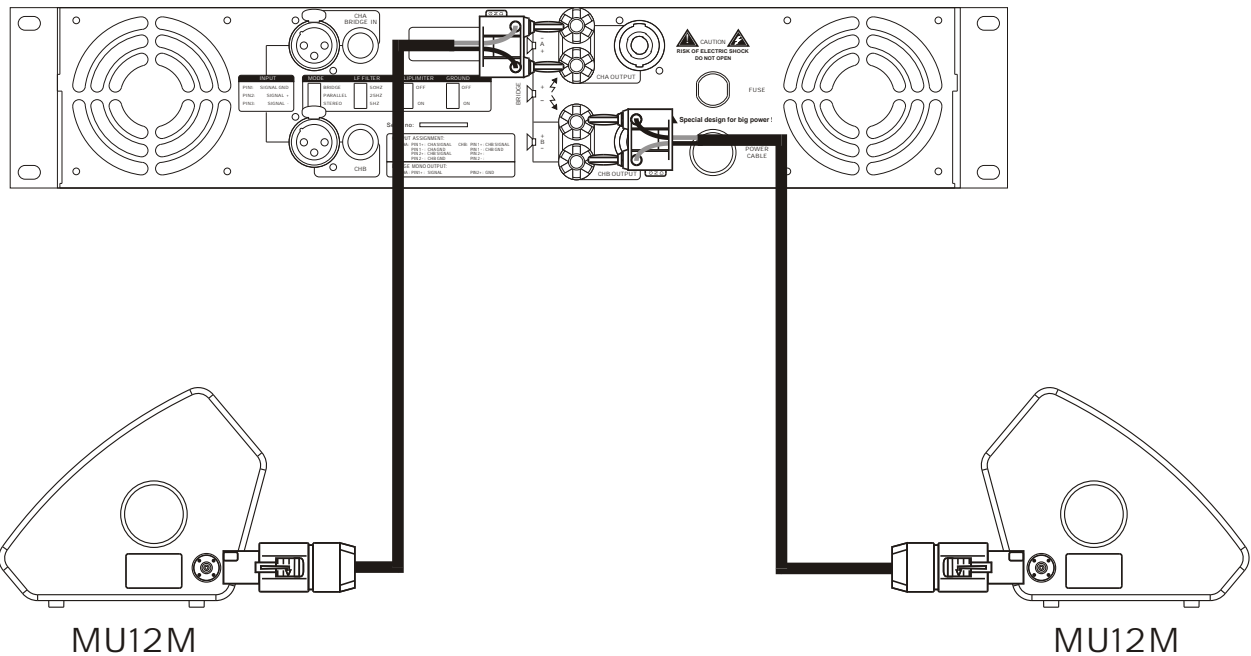

- ⚠ **Attention:** The impedance of connected speaker must match the impedance of amplifier output.
- ⚠ **Attention:** Make sure the polarity of speaker and amplifier correctly.

Speaker Wiring

1. Banana plugs to NL4

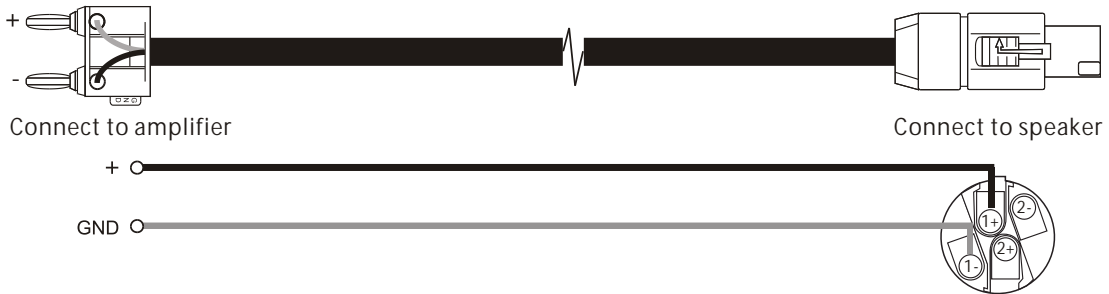

2. NL4 to NL4



3. Consumption curve of connection cable(Only for reference,the result is different if adopting the different cables)

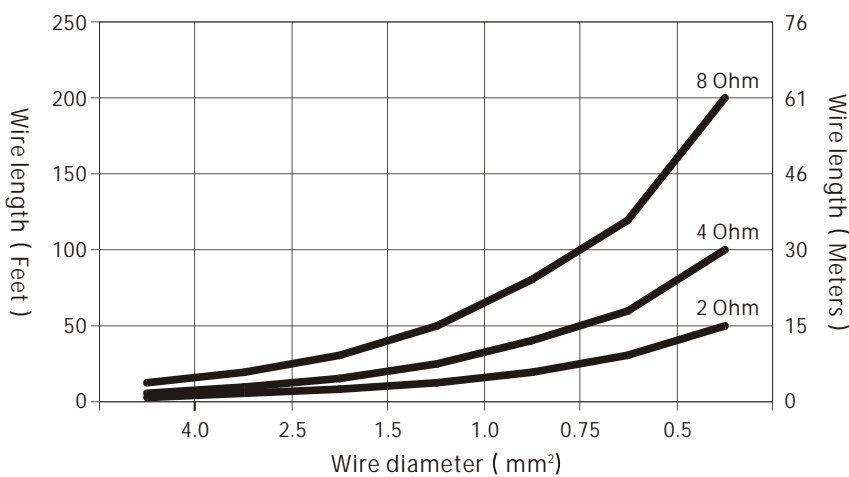

Specification

| | |
|---|--|
| System: | 12" passive monitor |
| Components: | 1 × 12" Neodymium woofer 1 Neodymium compression driver with 3" diaphragm |
| Frequency response(-3dB) ¹ : | 80Hz-16kHz |
| Sensitivity(1W@1m) ² : | 97dB |
| Max.SPL(1m) ³ : | 121dB/127dB(PEAK) |
| Power: | 350W (RMS) ⁴ 700W (MUSIC) 1400W (PEAK) |
| Dispersion (H × V) : | 45° × 45° |
| Monitor angle: | 50° |
| Rated impedance: | 8 Ohms |
| Crossover point: | 1.8kHz |
| Cabinet: | Wedge shape |
| Handle: | 2 × Wooden handles |
| Surface: | Polyurethane-based painting. Steel grille is coated by powder to provide strong ultra-Weatherability. |
| Connector: | 2 × NL4 |
| Cabinet dimension: | 410 × 548 × 450mm (W × D × H) (16.1 × 21.6 × 17.7in) |
| Package dimension: | 650 × 500 × 510mm (W × D × H) (25.6 × 19.7 × 20.1in) |
| N.W.(pc): | 19.3kg(42.5lbs) |
| G.W.(pc): | 21.5kg(47.3lbs) |

Speaker testing method

1. Frequency response

Use Pink noise to test the speaker in the anechoic room, adjust the level to make the speaker work at its rated impedance and the power output is 1W, then test the frequency response 1m away from the speaker.

2. Sensitivity

Use full range Pink noise which was modified by EQ curve to test the speaker in the anechoic room, enlarge the signal to make the speaker work at its rated impedance and the power output is 1W, then test the sensitivity 1m away from the speaker.

3. MAX.SPL

Use full range Pink noise which was modified by EQ curve to test the speaker in the anechoic room, enlarge the signal to make the speaker work at its instant power output level, then test the SPL 1m away from the speaker.

4. Rated Power

Use the pink noise according to IEC#268-5 to test the speaker, enlarge the signal for continuous 100hours, the rated Power is the power when the speaker will not incur hot damage or mechanics damage.

Frequency response curve & Impedance curve:

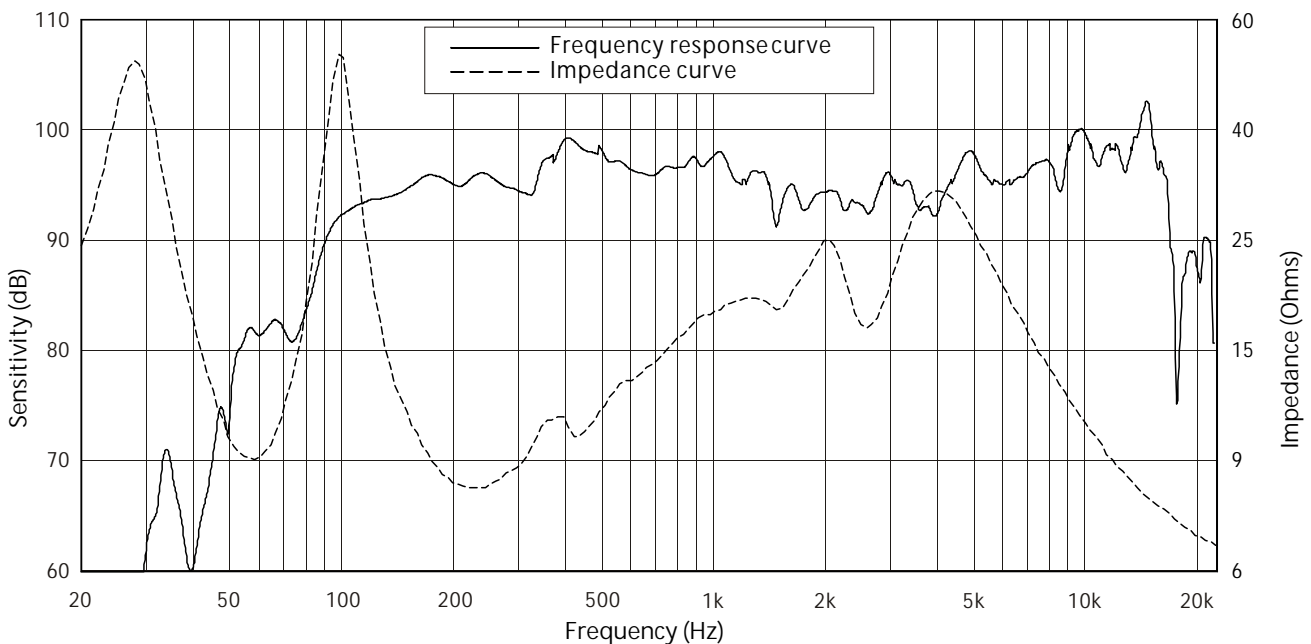

2D dimension

TopView

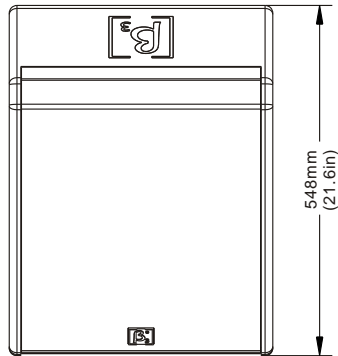

Side View

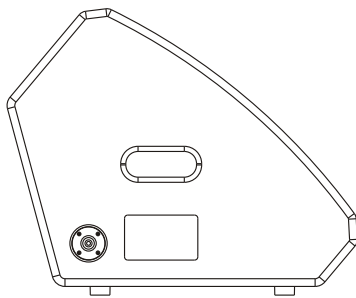

Front View

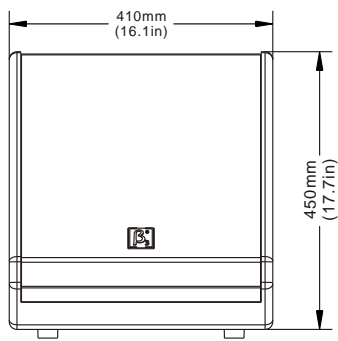

Rear View

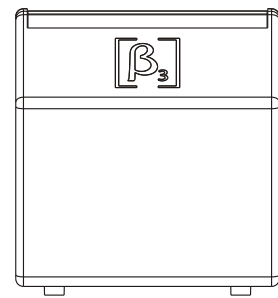

Bottom View

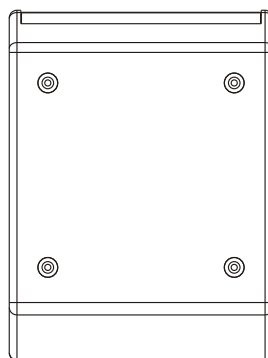

Notes



Beta Three